



Antron Electronics Co.,LTD
安雄電子股份有限公司

Constant Current LED Driver



Model Name	AC2800S200D
Output Mode	Constant Current
Input Voltage	120-277 Vac
Input Frequency	50/60 Hz
Dimming	3 in 1 (PWM, 1-10V, Resistance)
Surge Rating	3KV
Warranty	5 Years $TC \leq 75^{\circ}C$
	3 Years $75^{\circ}C \leq TC \leq 90^{\circ}C$

Product Specification



Output Power (W)	Output Voltage (V)	Output Current (A)	Start Temp. ($^{\circ}F/^{\circ}C$)	Tcase Temp. ($^{\circ}F/^{\circ}C$)	Input Current (A)	Input Power (W)	THD (%)	Power Factor	Efficiency (%)
Max. 200	43-71	2.8	Min -40/-40	Max. 194/90	1.78@120V 0.78@277V	225	Max. 20	Min. 0.9	Typ. 89

Wire Diagram

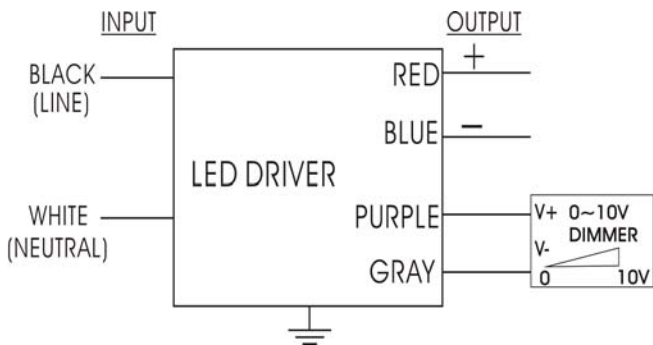

Maximum Wiring Distance(at full load) is 18AWG/18Feet

Enclosure

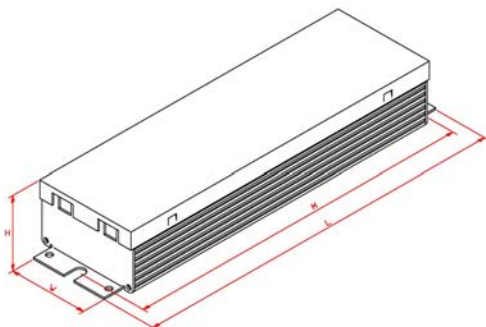

Lead Length	Inch	Cm
Black	5.9	15
White	5.9	15
Green	NA	NA
Red	5.9	15
Blue	5.9	15
Purple	7.1	18
Gray	7.1	18

Enclosure	Inch	Cm
Length(L)	9.5	24.1
Width(W)	2.6	6.6
Height(H)	1.6	4.05
Mounting(M)	8.9	22.6

Revised 2018/08/30