



Antron Electronics Co.,LTD
安雄電子股份有限公司

Constant Current LED Driver



Model Name	4C2100S150D
Output Mode	Constant Current
Input Voltage	347-480V Vac
Input Frequency	50/60 Hz
Dimming	3 in 1 (PWM, 1-10V, Resistance)
Surge Rating	3KV
Warranty	5 Years $TC \leq 75^{\circ}C$ 3 Years $75^{\circ}C \leq TC \leq 90^{\circ}C$

Product Specification

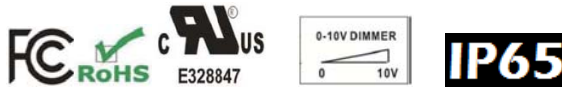

Output Power (W)	Output Voltage (V)	Output Current (A)	Start Temp. ($^{\circ}F/^{\circ}C$)	Tcase Temp. ($^{\circ}F/^{\circ}C$)	Input Current (A)	Input Power (W)	THD (%)	Power Factor	Efficiency (%)
Max. 150	43-71	2.1	Min -40/-40	Max. 194/90	0.48@347V 0.34@480V	170	Max. 20	Min. 0.9	Typ. 88

Wire Diagram

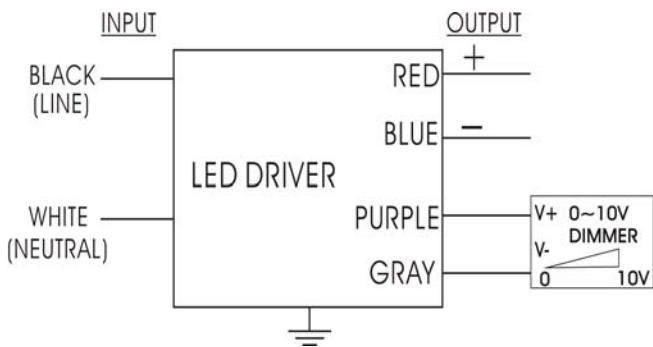

Maximum Wiring Distance(at full load) is 18AWG/18Feet

Enclosure

Lead Length	Inch	Cm
Black	5.9	15
White	5.9	15
Green	NA	NA
Red	5.9	15
Blue	5.9	15
Purple	7.1	18
Gray	7.1	18

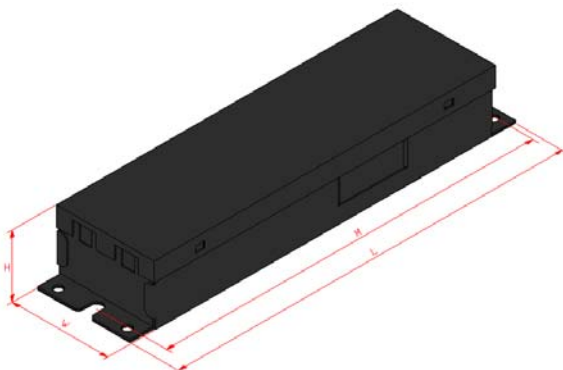

Enclosure	Inch	Cm
Length(L)	9.5	24.1
Width(W)	2.4	6.1
Height(H)	1.57	4.0
Mounting(M)	8.9	22.6

Revised 2018/08/30