



Antron Electronics Co.,LTD  
安雄電子股份有限公司

# Constant Current LED Driver



<b>Model Name</b>	AC3000S150D
<b>Output Mode</b>	Constant Current
<b>Input Voltage</b>	120-277 Vac
<b>Input Frequency</b>	50/60 Hz
<b>Dimming</b>	3 in 1 (PWM, 1-10V, Resistance)
<b>Surge Rating</b>	3KV
<b>Warranty</b>	5 Years $TC \leq 75^{\circ}C$ 3 Years $75^{\circ}C \leq TC \leq 90^{\circ}C$

## Product Specification



Output Power (W)	Output Voltage (V)	Output Current (A)	Start Temp. ( $^{\circ}F/^{\circ}C$ )	Tcase Temp. ( $^{\circ}F/^{\circ}C$ )	Input Current (A)	Input Power (W)	THD (%)	Power Factor	Efficiency (%)
Max. 150	30-50	3.0	Min -40/-40	Max. 194/90	1.46@120V 0.64@277V	170	Max. 20	Min. 0.9	Typ. 89

## Wire Diagram

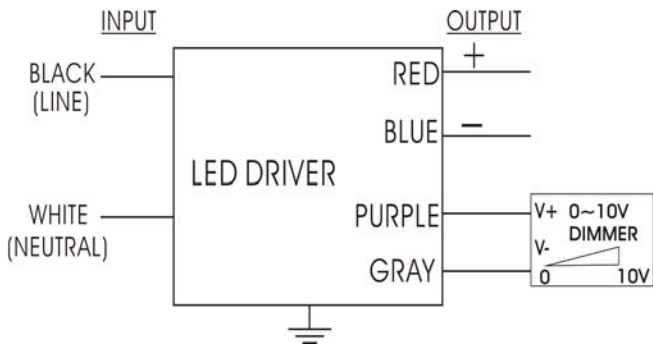

Maximum Wiring Distance(at full load) is 18AWG/18Feet

## Enclosure

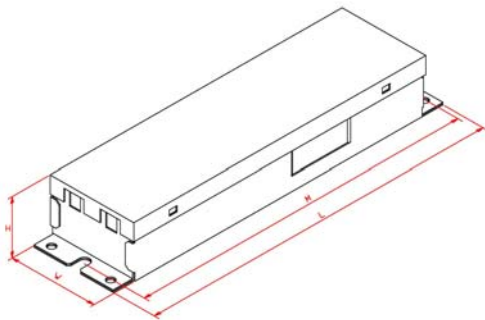

Lead Length	Inch	Cm
Black	5.9	15
White	5.9	15
Green	NA	NA
Red	5.9	15
Blue	5.9	15
Purple	7.1	18
Gray	7.1	18

Enclosure	Inch	Cm
Length(L)	9.5	24.1
Width(W)	2.4	6.1
Height(H)	1.57	4.0
Mounting(M)	8.9	22.6

Revised 2018/08/21